

LIDER

ENTRANCE MATS



You have only one chance for good, first impression.

LIDER Iwona Sozańska
Ul. Przemysłowa 35a
66-400 Gorzów Wlkp.
POLSKA
www.entrancemats-kuwait.com



Welcome to the world of high-quality object doormats „Broxo”. Aluminum doormats produced by LIDER Company from Gorzów Wlkp., are available in wide variety of colours and shapes. They create aesthetic business card of each building, object or space. We are licenced producer of object doormats German brand LOLA.

To protect the building’s floor, doormat is an essential element. Thanks to the doormat dirt, dust and humidity can’t get into interior space.

System doormats are being mounted in many representative buildings. Their size and shape is being properly selected right to specific place where it is going to be applied.

Our doormats are effective, aesthetic and very durable what makes them most chosen product by architects in region of whole Poland. In order to find out more about their wide range, please visit tab “doormats” on our website.

Table of contents

- 1 Three cleaning zones
- 2 Available fulfilments

Indoor Lux Doormats

- 4 Broxotop-F-lux
- 5 Broxotop-F-KK-lux
- 6 Broxostep-lux
- 7 Broxostep-KK-lux
- 8 Broxostep-Spezial-lux
- 9 Broxostep-Spezial 2:1 - lux
- 10 Broxostep-Spezial 3:1 - lux

Indoor Standard doormats

- 11 Broxotop-F-standard
- 12 Broxotop-F+G-standard
- 13 Broxotop-F-KK-standard
- 14 Broxostep-standard
- 15 Broxostep-KK-standard
- 16 Broxostep+Rip-standard
- 17 Broxostep-Spezial-standard
- 18 Broxostep-Spezial 2:1-standard
- 19 Broxostep-Spezial 3:1-standard

Outdoor doormats

- 20 Broxotop-G
- 21 Broxotop-G-KK
- 22 Broxorip
- 23 Broxorip-KK
- 24 Broxorip-Spezial
- 25 Broxorip-Spezial 2:1
- 26 Broxorip-Spezial 3:1
- 27 Broxoflex
- 28 Broxoflex-EK
- 29 Broxoflex-CB

- 30 Usage instruction and conservation of objects' doormats floor system
- 31 Installation of doormats manufactured by Lider company by using aluminium frames
- 32 Division of our doormats into modules

Zone 1 – Cleaning coarse dirt

- outdoor, directly in front entrance to the building
- doormats resistant to all kinds of atmospheric conditions (frost, snow, rain, sun)
- Recommended cleaning contributions: brush, rubber, aluminium flat bar.

Zone 2 - Tertiary treatment of remaining dirt, partial drying

- directly after entering the building (for example: vestibule, staircase)
- recommended contributions: rubber, brush, carpet

Zone 3 – drying

- next chambers after crossing vestibule or staircase (for example: hall, reception)
- recommended contribution : carpet

3. Drying zone (inner)

2. Proper cleaning zone (inner)

1. Pre-cleaning zone (inner)

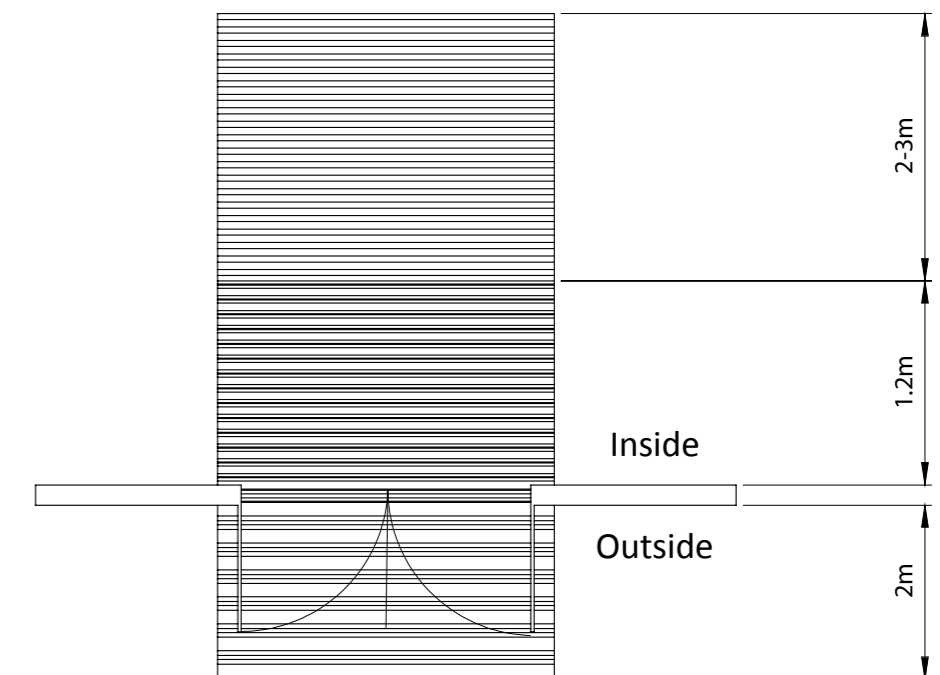

Available variants

Lux carpet colours:

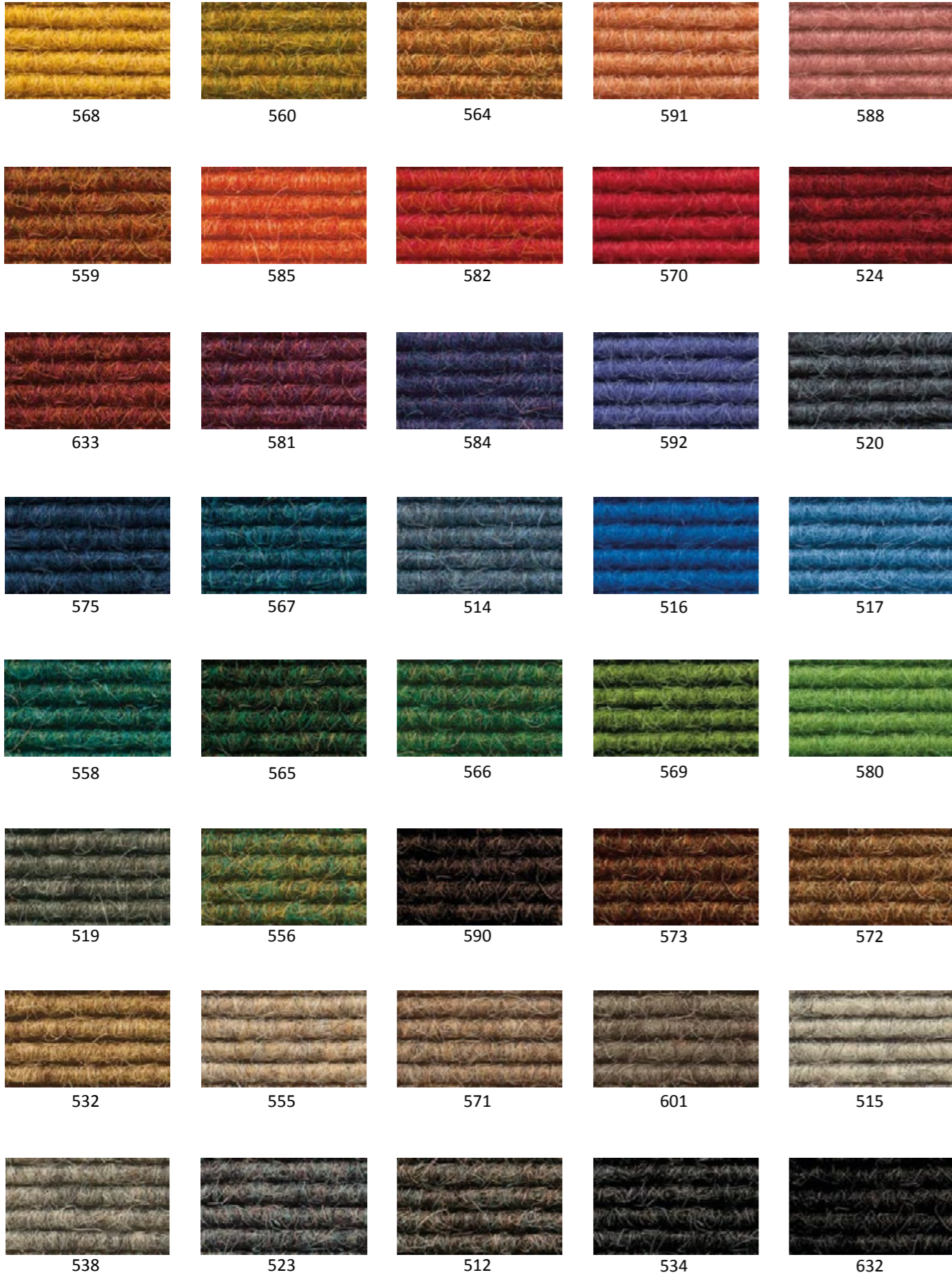

LIDER

LIDER

Standard carpet colours:



Rubber colours:

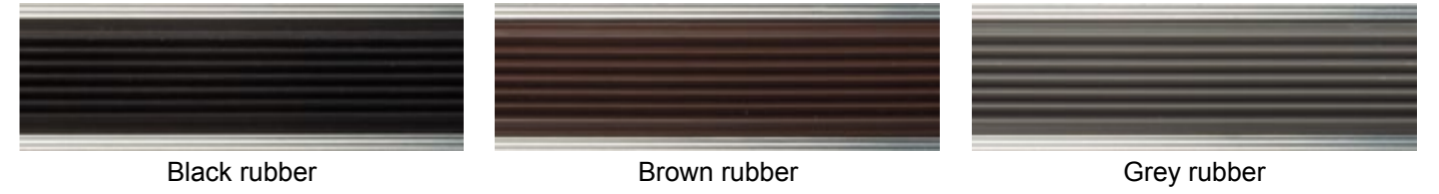

Brush colours:

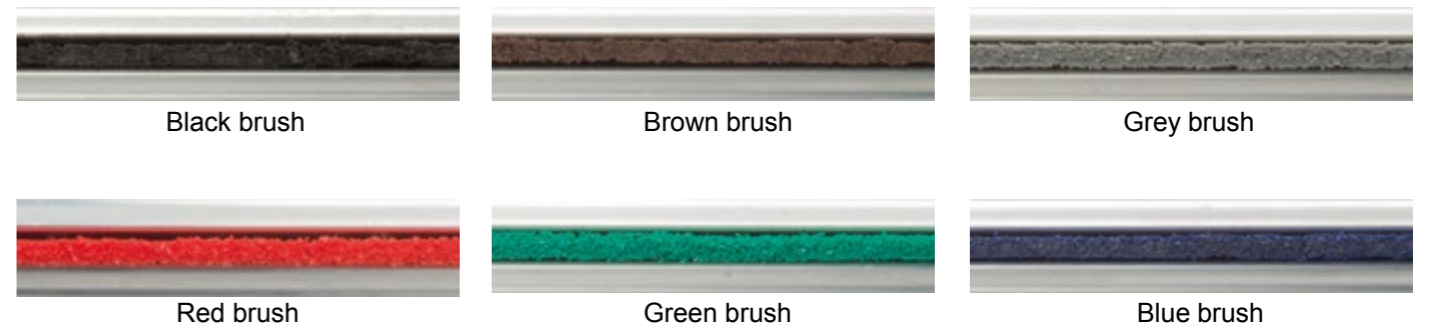

Broxotop-F-lux



DESCRIPTION: Rolled doormat, dedicated for indoor spaces (zone no 3) for shoe sole drainage. It's used together with carpet contribution from our Lux range. To be used in medium-traffic pedestrian places with participation of shopping trolleys, wheelchairs for example for hotels, office buildings, shops and residential buildings.

DATA SHEET

Application area	Indoor use
Material	Bracket profile – aluminium - alloy 6060T6 Cleaning contribution: carpet – composition: 80% goat fur, 20% sheep wool Stainless steel wire rope - 2 mm diameter Distance bushes: width 3mm, 5mm - PVC of hardness 75Sha Nickel plated terminal keys, acoustic tape (bottom of the profiles)
Profile's hight	9,7mm
Mat's hight	14,00mm
Mat's weight	With distance bush 3mm – 12,00kg With distance bush 5mm – 11,00kg
Available colours	Aluminium bracket profiles: natural – silver, on request all RAL colours Carpet - Lux: 40 colours from Lux range

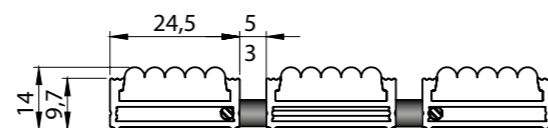

LUX DOORMATS – AVAILABLE IN 40 COLOURS OF CARPETS, SEE PAGE 2.



Broxotop-F-KK-lux

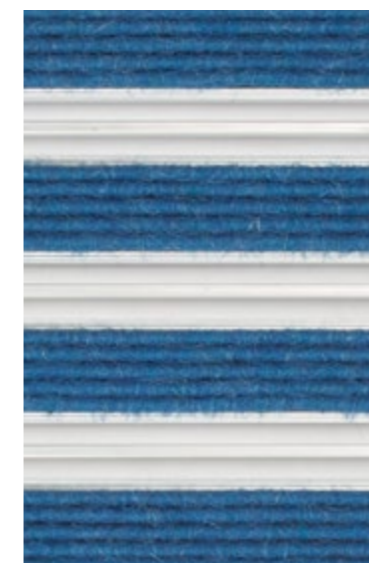
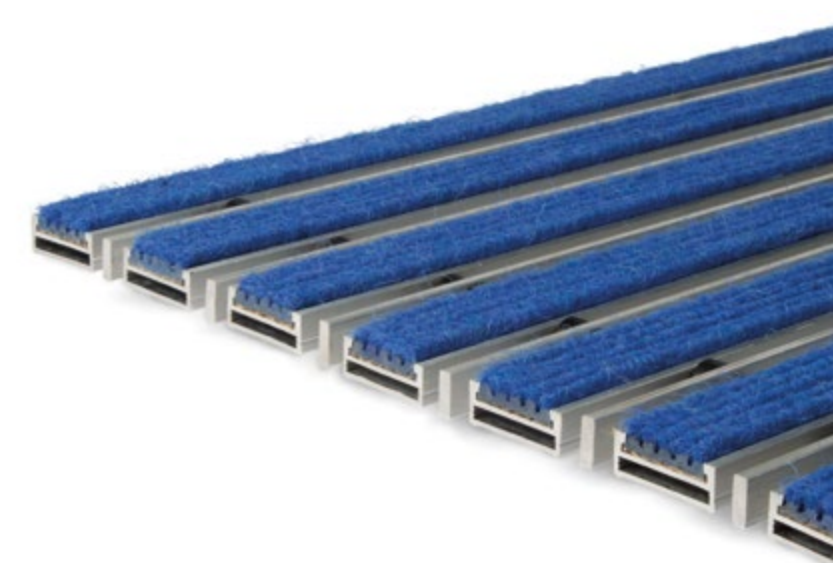

DESCRIPTION: Rolled doormat, dedicated for indoor spaces (zone no 2 and 3) for shoe sole cleaning and drainage. It's used together with carpet contribution from our Lux range. To be used in medium-traffic pedestrian places with participation of shopping trolleys, wheelchairs for example for hotels, office buildings, shops and residential buildings.

DATA SHEET

Application area	Indoor use
Material	Bracket profile – aluminium - alloy 6060T6 Aluminium flat bar 3x10mm – stop 6060T6 Cleaning contribution: carpet – composition: 80% goat fur, 20% sheep wool Stainless steel wire rope - 2 mm diameter Distance bushes: width 3mm, 5mm - PVC of hardness 75Sha Nickel plated terminal keys, acoustic tape (bottom of the profiles)
Profile's hight	9,7mm
Mat's hight	14,00mm
Mat's weight	With distance bush 3mm – 11,00kg With distance bush 5mm – 10,50kg
Available colours	Aluminium bracket profiles, flat bars: natural – silver, on request all RAL colours Carpet - Lux: 40 colours from Lux range

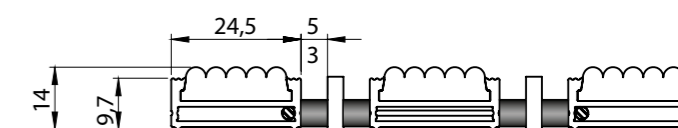

LUX DOORMATS – AVAILABLE IN 40 COLOURS OF CARPETS, SEE PAGE 2.



Broxostep-lux

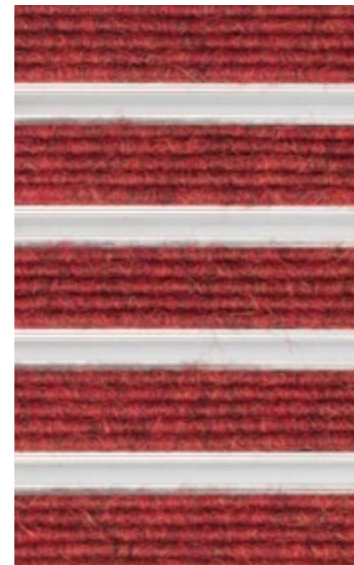
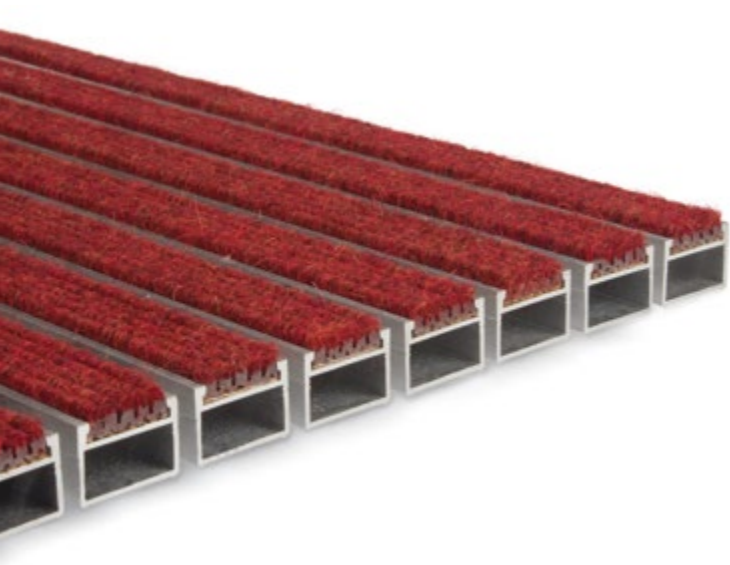

DESCRIPTION: Rolled doormat, dedicated for indoor spaces (zone no 3) for shoe sole drainage. It's used together with carpet contribution from our Lux range. To be used in high-traffic pedestrian places with participation of shopping trolleys, wheelchairs for example for hotels, office buildings, shops and residential buildings.

DATA SHEET

Application area	Indoor use
Material	Bracket profile – aluminium - alloy 6060T6 Cleaning contribution: carpet – composition: 80% goat fur, 20% sheep wool Stainless steel wire rope - 2 mm diameter Distance bushes: width 3mm, 5mm - PVC of hardness 75Sha Nickel plated terminal keys, acoustic tape (bottom of the profiles)
Profile's hight	17,5mm
Mat's hight	22,00mm
Mat's weight	With distance bush 3mm – 13,00kg With distance bush 5mm – 12,00kg
Available colours	Aluminium bracket profiles: natural – silver, on request all RAL colours Carpet - Lux: 40 colours from Lux range

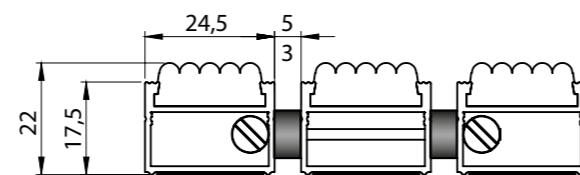

LUX DOORMATS – AVAILABLE IN 40 COLOURS OF CARPETS, SEE PAGE 2.



Broxostep-KK-lux

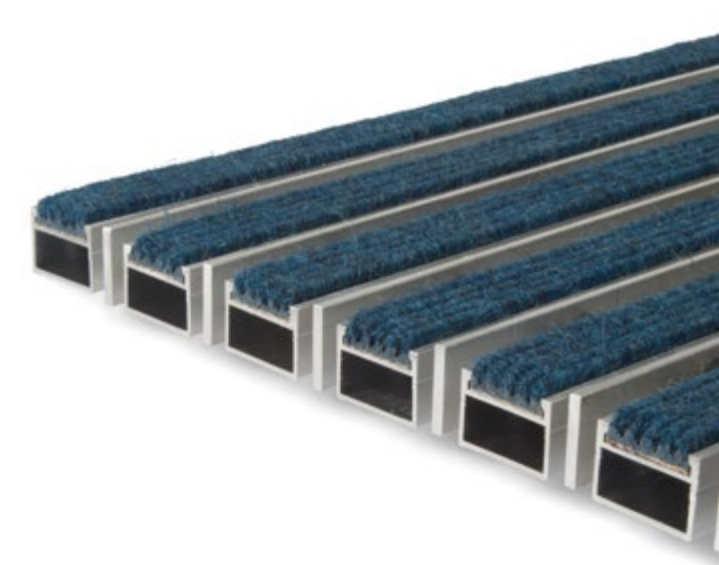

DESCRIPTION: Rolled doormat, dedicated for indoor spaces (zone no 2 and 3) for shoe sole cleaning and drainage. It's used together with carpet contribution from our Lux range and scraping aluminium flat bar. To be used in high-traffic pedestrian places with participation of shopping trolleys, wheelchairs for example for hotels, office buildings, shops and residential buildings.

DATA SHEET

Application area	Indoor use
Material	Bracket profile – aluminium - alloy 6060T6 Aluminium flat bar 3x20mm – stop 6060T6 Cleaning contribution: carpet – composition: 80% goat fur, 20% sheep wool Stainless steel wire rope - 2 mm diameter Distance bushes: width 3mm, 5mm - PVC of hardness 75Sha Nickel plated terminal keys, acoustic tape (bottom of the profiles)
Profile's hight	17,5mm
Mat's hight	22,00mm
Mat's weight	With distance bush 3mm – 14,50kg With distance bush 5mm – 13,50kg
Available colours	Aluminium bracket profiles, flat bars: natural – silver, on request all RAL colours Carpet - Lux: 40 colours from Lux range

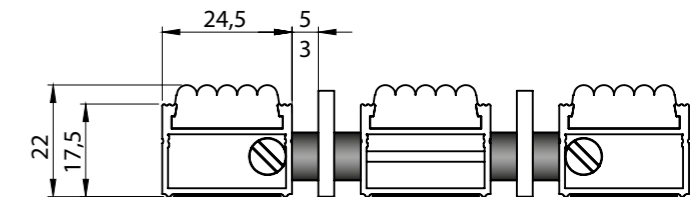

LUX DOORMATS – AVAILABLE IN 40 COLOURS OF CARPETS, SEE PAGE 2.

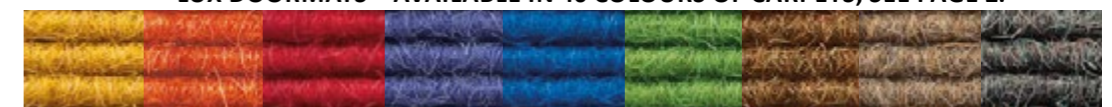

Broxostep-Spezial-lux

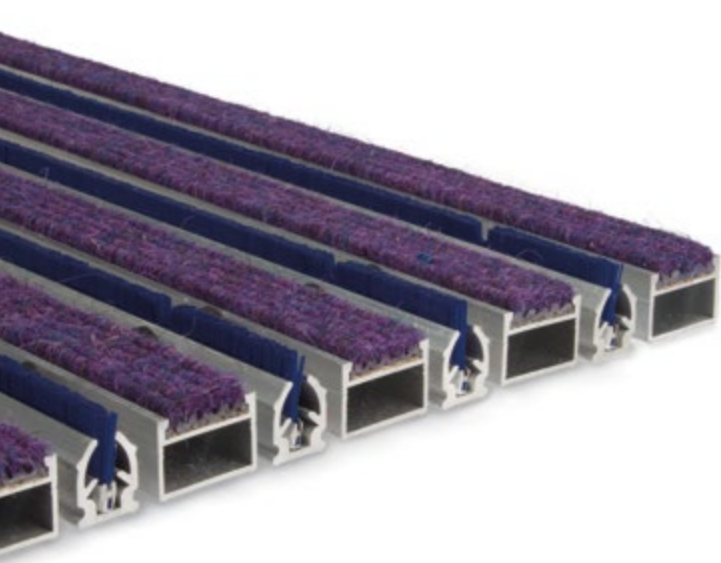

DESCRIPTION: Rolled doormat, dedicated for indoor spaces (zone no 2 and 3) for shoe sole cleaning and drainage. It's used together with carpet contribution from our Lux range and aluminium scraping brush, 1:1 carpet to brush ratio. To be used in high-traffic pedestrian places with participation of shopping trolleys, wheelchairs for example for hotels, office buildings, shops and residential buildings.

DATA SHEET

Application area	Indoor use
Material	Bracket profile – aluminium - alloy 6060T6 Cleaning contribution: carpet – composition: 80% goat fur, 20% sheep wool, nylon scraping brush – nylon 0,4mm Stainless steel wire rope - 2 mm diameter Distance bushes: width 3mm, 5mm - PVC of hardness 75Sha Nickel plated terminal keys, acoustic tape (bottom of the profiles)
Profile's hight	17,5mm
Mat's hight	22,00mm
Mat's weight	With distance bush 3mm – 17,00kg With distance bush 5mm – 16,00kg
Available colours	Aluminium bracket profiles: natural – silver, on request all RAL colours Carpet - Lux: 40 colours from Lux range Scraping brushes: black, grey, brown, red, green, blue

SCRAPING BRUSHES

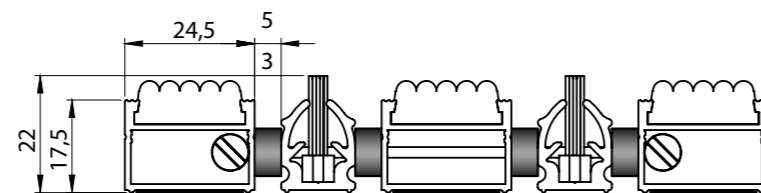
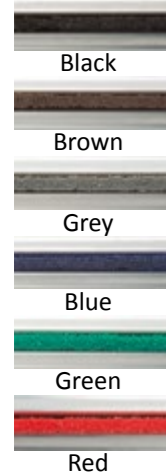

LUX DOORMATS – AVAILABLE IN 40 COLOURS OF CARPETS, SEE PAGE 2.



Broxostep-Spezial 2:1 - lux

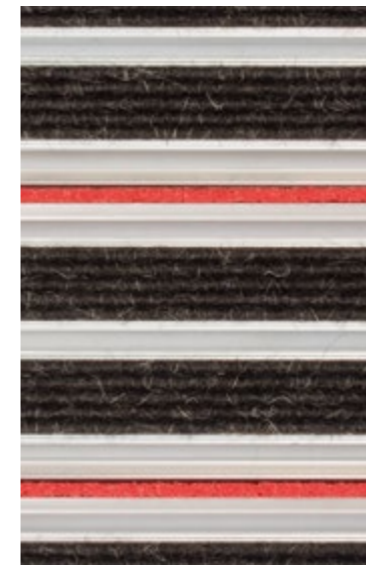

DESCRIPTION: Rolled doormat, dedicated for indoor spaces (zone no 2 and 3) for shoe sole cleaning and drainage. It's used together with carpet contribution from our Lux range and aluminium scraping brush, 2:1 carpet to brush ratio. To be used in high-traffic pedestrian places with participation of shopping trolleys, wheelchairs for example for hotels, office buildings, shops and residential buildings.

DATA SHEET

Application area	Indoor use
Material	Bracket profile – aluminium - alloy 6060T6 Cleaning contribution: carpet – composition: 80% goat fur, 20% sheep wool, Nylon scraping brush – nylon 0,4mm Stainless steel wire rope - 2 mm diameter Distance bushes: width 3mm, 5mm - PVC of hardness 75Sha Nickel plated terminal keys, acoustic tape (bottom of the profiles)
Profile's hight	17,5mm
Mat's hight	22,00mm
Mat's weight	With distance bush 3mm – 15,00kg With distance bush 5mm – 14,00kg
Available colours	Aluminium bracket profiles: natural – silver, on request all RAL colours Carpet - Lux: 40 colours from Lux range Scraping brushes: black, grey, brown, red, green, blue

SCRAPING BRUSHES

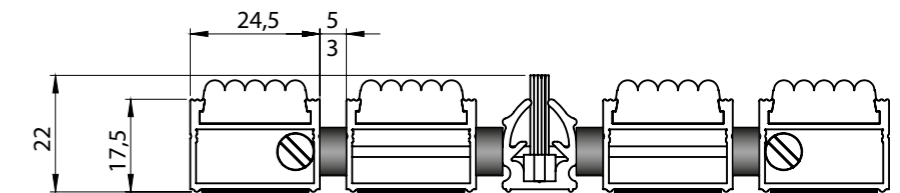
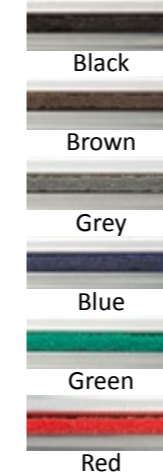

LUX DOORMATS – AVAILABLE IN 40 COLOURS OF CARPETS, SEE PAGE 2.



Broxostep-Spezial 3:1 - lux

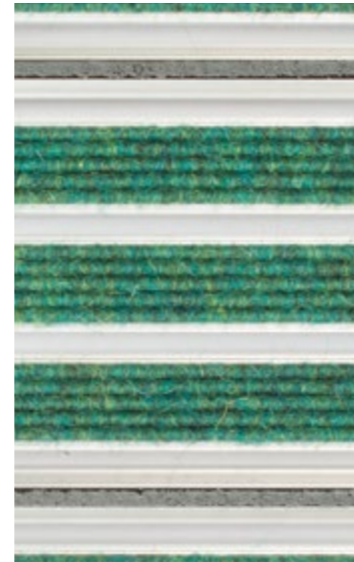
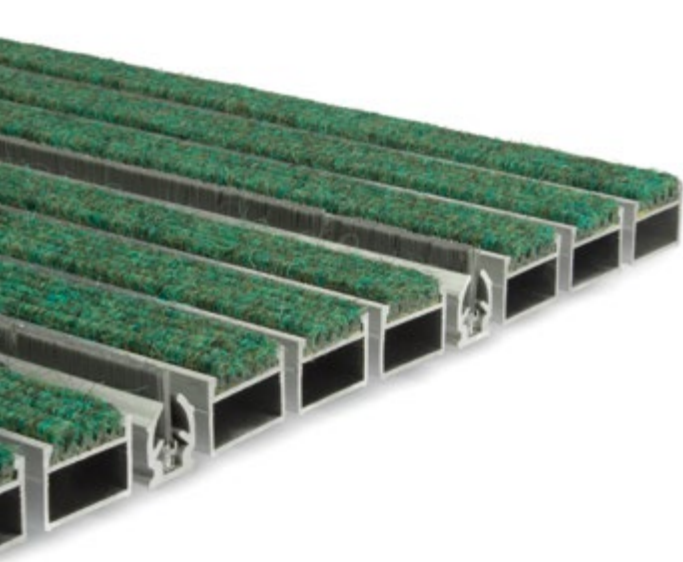

DESCRIPTION: Rolled doormat, dedicated for indoor spaces (zone no 2 and 3) for shoe sole cleaning and drainage. It's used together with carpet contribution from our Lux range and aluminium scraping brush, 3:1 carpet to brush ratio. To be used in high-traffic pedestrian places with participation of shopping trolleys, wheelchairs for example for hotels, office buildings, shops and residential buildings.

DATA SHEET

Application area	Indoor use
Material	Bracket profile – aluminium - alloy 6060T6 Cleaning contribution: carpet – composition: 80% goat fur, 20% sheep wool, Nylon scraping brush – nylon 0,4mm Stainless steel wire rope - 2 mm diameter Distance bushes: width 3mm, 5mm - PVC of hardness 75Sha Nickel plated terminal keys, acoustic tape (bottom of the profiles)
Profile's hight	17,5mm
Mat's hight	22,00mm
Mat's weight	With distance bush 3mm – 14,00kg With distance bush 5mm – 13,00kg
Available colours	Aluminium bracket profiles: natural – silver, on request all RAL colours Carpet - Lux: 40 colours from Lux range Scraping brushes: black, grey, brown, red, green, blue

Broxotop-F-standard



DESCRIPTION: Rolled doormat, dedicated for indoor spaces (zone no 3) for shoe sole drainage. To be used in medium-traffic pedestrian places with participation of shopping trolleys, wheelchairs for example for hotels, office buildings, shops and residential buildings.

DATA SHEET

Application area	Indoor use
Material	Bracket profile – aluminium - alloy 6060T6 Cleaning contribution: carpet – polypropylene Stainless steel wire rope - 2 mm diameter Distance bushes: width 3mm, 5mm - PVC of hardness 75Sha Nickel plated terminal keys, acoustic tape (bottom of the profiles)
Profile's hight	9,7mm
Mat's hight	12,00mm
Mat's weight	With distance bush 3mm – 10,00kg With distance bush 5mm – 9,50kg
Available colours	Aluminium bracket profiles: natural – silver, on request all RAL colours Carpet - Standard: anthracite, grey, brown

SCRAPING BRUSHES

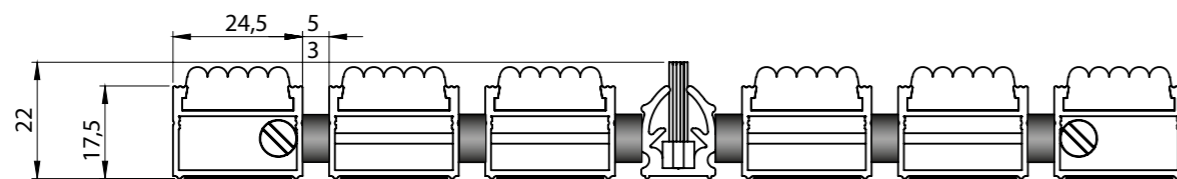

LUX DOORMATS – AVAILABLE IN 40 COLOURS OF CARPETS, SEE PAGE 2.

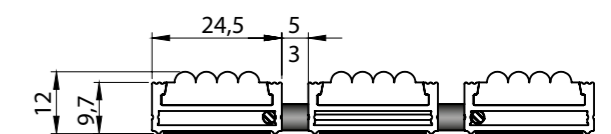

CARPET - STANDARD



Broxotop-F+G-standard



DESCRIPTION: Rolled doormat, dedicated for indoor spaces (zone no 2 and 3) for shoe sole cleaning and drainage. To be used in medium-traffic pedestrian places with participation of shopping trolleys, wheelchairs for example for hotels, office buildings, shops and residential buildings.

DATA SHEET

Application area	Indoor use
Material	Bracket profile – aluminium - alloy 6060T6 Cleaning contribution: carpet – polypropylene Grooved rubber (vinyl) – black, grey, brown Stainless steel wire rope - 2 mm diameter Distance bushes: width 3mm, 5mm - PVC of hardness 75Sha Nickel plated terminal keys, acoustic tape (bottom of the profiles)
Profile's height	9,7mm
Mat's height	12,00mm
Mat's weight	With distance bush 3mm – 10,5kg With distance bush 5mm – 9,50kg
Available colours	Aluminium bracket profiles: natural – silver, on request all RAL colours Carpet - Standard: anthracite, grey, brown Grooved rubber (vinyl): black, grey, brown

RUBBER



Black



Brown



Grey

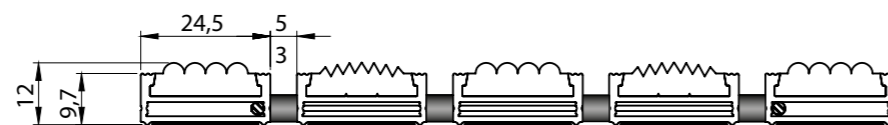

CARPET - STANDARD



Anthracite

Brown

Grey

Broxotop-F-KK-standard



DESCRIPTION: Rolled doormat, dedicated for indoor spaces (zone no 2 and 3) for shoe sole cleaning and drainage. To be used in medium-traffic pedestrian places with participation of shopping trolleys, wheelchairs for example for hotels, office buildings, shops and residential buildings.

DATA SHEET

Application area	Indoor use
Material	Bracket profile – aluminium - alloy 6060T6 Aluminium flat bar 3x10mm – stop 6060T6 Cleaning contribution: carpet – polypropylene Stainless steel wire rope - 2 mm diameter Distance bushes: width 3mm, 5mm - PVC of hardness 75Sha Nickel plated terminal keys, acoustic tape (bottom of the profiles)
Profile's height	9,7mm
Mat's height	12,00mm
Mat's weight	With distance bush 3mm – 10,0kg With distance bush 5mm – 9,0kg
Available colours	Aluminium bracket profiles, flat bars: natural – silver, on request all RAL colours Carpet - Standard: anthracite, grey, brown

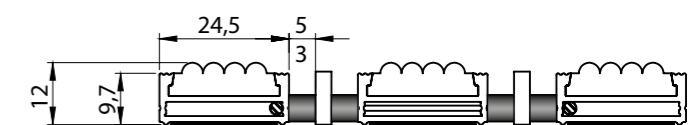

CARPET - STANDARD



Anthracite

Brown

Grey

Broxostep-standard

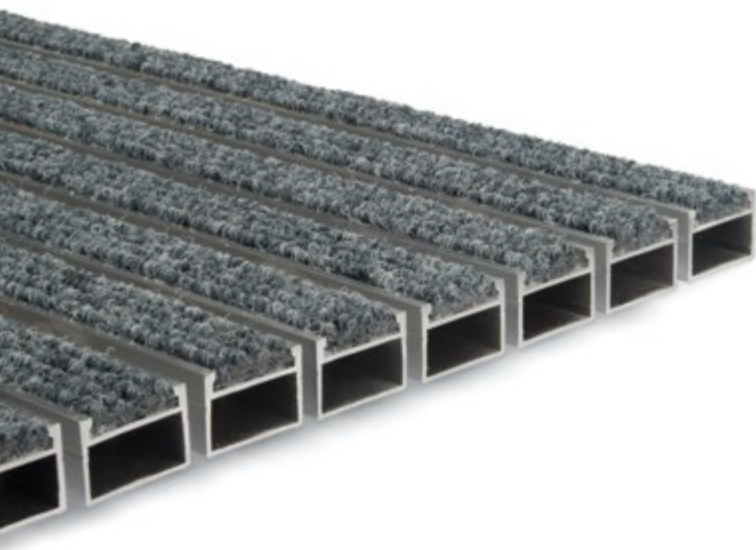

DESCRIPTION: Rolled doormat, dedicated for indoor spaces (zone no 3) for shoe sole drainage. To be used in high-traffic pedestrian places with participation of shopping trolleys, wheelchairs for example for hotels, office buildings, shops and residential buildings.

DATA SHEET

Application area	Indoor use
Material	Bracket profile – aluminium - alloy 6060T6 Cleaning contribution: carpet – polypropylene Stainless steel wire rope - 2 mm diameter Distance bushes: width 3mm, 5mm - PVC of hardness 75Sha Nickel plated terminal keys, acoustic tape (bottom of the profiles)
Profile's hight	17,5mm
Mat's hight	20,00mm
Mat's weight	With distance bush 3mm – 12,00kg With distance bush 5mm – 11,00kg
Available colours	Aluminium bracket profiles: natural – silver, on request all RAL colours Carpet - Standard: anthracite, grey, brown

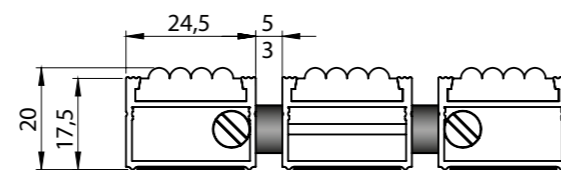

CARPET - STANDARD



Broxostep-KK-standard



DESCRIPTION: Rolled doormat, dedicated for indoor spaces (zone no 2 and 3) for shoe sole cleaning and drainage. To be used in high-traffic pedestrian places with participation of shopping trolleys, wheelchairs for example for hotels, office buildings, shops and residential buildings.

DATA SHEET

Application area	Indoor use
Material	Bracket profile – aluminium - alloy 6060T6 Aluminium flat bar – 3x20mm- alloy 6060T6 Cleaning contribution: carpet – polypropylene Stainless steel wire rope - 2 mm diameter Distance bushes: width 3mm, 5mm - PVC of hardness 75Sha Nickel plated terminal keys, acoustic tape (bottom of the profiles)
Profile's hight	17,5mm
Mat's hight	20,00mm
Mat's weight	With distance bush 3mm – 14,00kg With distance bush 5mm – 13,50kg
Available colours	Aluminium bracket profiles, flat bars: natural – silver, on request all RAL colours Carpet - Standard: anthracite, grey, brown

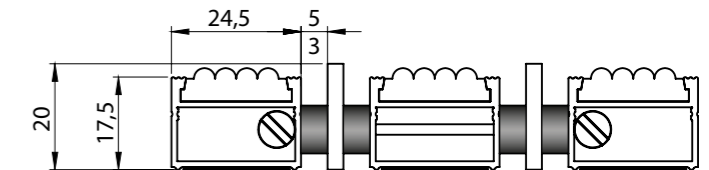

CARPET - STANDARD



Broxostep+Rip-standard



DESCRIPTION: Rolled doormat, dedicated for indoor spaces (zone no 2 and 3) for shoe sole cleaning and drainage. To be used in high-traffic pedestrian places with participation of shopping trolleys, wheelchairs for example for hotels, office buildings, shops and residential buildings.

DATA SHEET

Application area	Indoor use
Material	Bracket profile – aluminium - alloy 6060T6 Cleaning contribution: carpet – polypropylene Grooved rubber (vinyl): black, grey, brown Stainless steel wire rope - 2 mm diameter Distance bushes: width 3mm, 5mm - PVC of hardness 75Sha Nickel plated terminal keys, acoustic tape (bottom of the profiles)
Profile's hight	17,5mm
Mat's hight	20,00mm
Mat's weight	With distance bush 3mm – 13,00kg With distance bush 5mm – 12,00kg
Available colours	Aluminium bracket profiles: natural – silver, on request all RAL colours Carpet - Standard: anthracite, grey, brown Grooved rubber (vinyl): black, grey, brown

RUBBER



Black



Brown



Grey

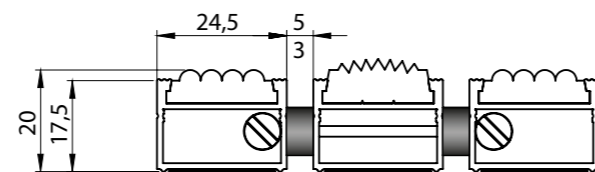

CARPET - STANDARD



Anthracite

Brown

Grey

Broxostep-Spezial-standard



DESCRIPTION: Rolled doormat, dedicated for indoor spaces (zone no 2 and 3) for shoe sole cleaning and drainage. To be used in high-traffic pedestrian places with participation of shopping trolleys, wheelchairs for example for hotels, office buildings, shops and residential buildings.

DATA SHEET

Application area	Indoor use
Material	Bracket profile – aluminium - alloy 6060T6 Cleaning contribution: carpet – polypropylene Scraping brush : nylon 0,4mm Stainless steel wire rope - 2 mm diameter Distance bushes: width 3mm, 5mm - PVC of hardness 75Sha Nickel plated terminal keys, acoustic tape (bottom of the profiles)
Profile's hight	17,5mm
Mat's hight	20,00mm-22,00mm
Mat's weight	With distance bush 3mm – 15,00kg With distance bush 5mm – 14,50kg
Available colours	Aluminium bracket profiles: natural – silver, on request all RAL colours Carpet - Standard: anthracite, grey, brown Nylon scraping brushes: black, grey, brown, red, green, blue

SCRAPING BRUSHES



Black



Brown

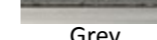

Grey

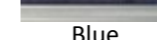

Blue

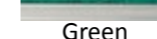

Green

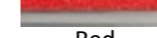

Red

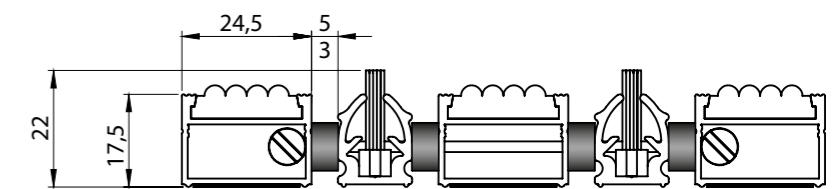

CARPET - STANDARD



Anthracite

Brown

Grey

Broxostep-Spezial 2:1-standard



DESCRIPTION: Rolled doormat, dedicated for indoor spaces (zone no 2 and 3) for shoe sole cleaning and drainage. To be used in high-traffic pedestrian places with participation of shopping trolleys, wheelchairs for example for hotels, office buildings, shops and residential buildings.

DATA SHEET

Application area	Indoor use
Material	Bracket profile – aluminium - alloy 6060T6 Cleaning contribution: carpet – polypropylene Scraping brush : nylon 0,4mm Stainless steel wire rope - 2 mm diameter Distance bushes: width 3mm, 5mm - PVC of hardness 75Sha Nickel plated terminal keys, acoustic tape (bottom of the profiles)
Profile's hight	17,5mm
Mat's hight	20,00mm-22,00mm
Mat's weight	With distance bush 3mm – 13,00kg With distance bush 5mm – 12,50kg
Available colours	Aluminium bracket profiles: natural – silver, on request all RAL colours Carpet - Standard: anthracite, grey, brown Nylon scraping brushes: black, grey, brown, red, green, blue

SCRAPING BRUSHES

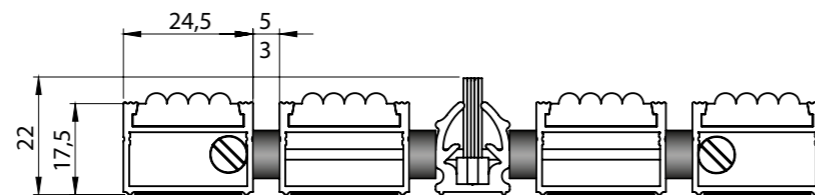
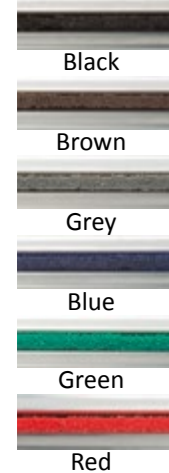

CARPET - STANDARD



Broxostep-Spezial 3:1-standard



DESCRIPTION: Rolled doormat, dedicated for indoor spaces (zone no 2 and 3) for shoe sole cleaning and drainage. To be used in high-traffic pedestrian places with participation of shopping trolleys, wheelchairs for example for hotels, office buildings, shops and residential buildings.

DATA SHEET

Application area	Indoor use
Material	Bracket profile – aluminium - alloy 6060T6 Cleaning contribution: carpet – polypropylene Scraping brush : nylon 0,4mm Stainless steel wire rope - 2 mm diameter Distance bushes: width 3mm, 5mm - PVC of hardness 75Sha Nickel plated terminal keys, acoustic tape (bottom of the profiles)
Profile's hight	17,5mm
Mat's hight	20,00mm-22,00mm
Mat's weight	With distance bush 3mm – 12,50kg With distance bush 5mm – 12,00kg
Available colours	Aluminium bracket profiles: natural – silver, on request all RAL colours Carpet - Standard: anthracite, grey, brown Nylon scraping brushes: black, grey, brown, red, green, blue

SCRAPING BRUSHES

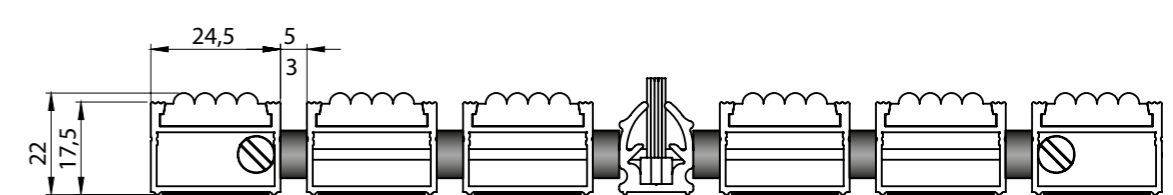
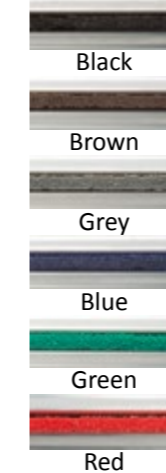

CARPET - STANDARD



Broxotop-G



DESCRIPTION: Rolled doormat, dedicated for outdoor and indoor spaces (zone no 2 and 3) for shoe sole cleaning. With used anti-slip rubber. To be used in medium-traffic pedestrian places with participation of shopping trolleys, wheelchairs for example for hotels, office buildings, shops and residential buildings.

DATA SHEET

Application area	Outdoor and indoor use
Material	Bracket profile – aluminium - alloy 6060T6 Cleaning contribution: anti-slip rubber (7 teeth) – PVC – 72Sha Stainless steel wire rope - 2 mm diameter Distance bushes: width 3mm, 5mm - PVC of hardness 75Sha Nickel plated terminal keys, acoustic tape (bottom of the profiles)
Profile's hight	9,7mm
Mat's hight	12,00mm
Mat's weight	With distance bush 3mm – 12,00kg With distance bush 5mm – 11,00kg
Available colours	Aluminium bracket profiles: natural – silver, on request all RAL colours Anti-slip rubber: black, grey, brown

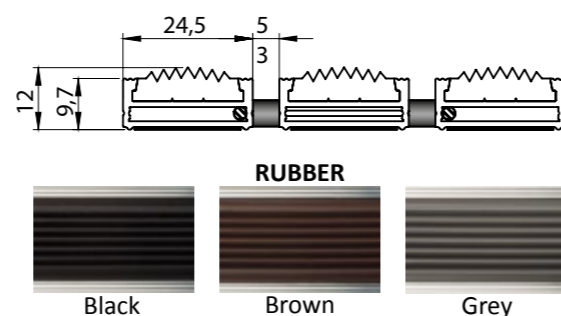

LIDER

LIDER

Broxotop-G-KK



DESCRIPTION: Rolled doormat, dedicated for outdoor and indoor spaces (zone no 1 and 2) for shoe sole cleaning. With used anti-slip rubber and aluminium flat bar. To be used in medium-traffic pedestrian places with participation of shopping trolleys, wheelchairs for example for hotels, office buildings, shops and residential buildings.

DATA SHEET

Application area	Outdoor and indoor use
Material	Bracket profile – aluminium - alloy 6060T6 Aluminium flat bar 3x10mm – stop 6060T6 Cleaning contribution: anti-slip rubber (7 teeth) – PVC – 72Sha Stainless steel wire rope - 2 mm diameter Distance bushes: width 3mm, 5mm - PVC of hardness 75Sha Nickel plated terminal keys, acoustic tape (bottom of the profiles)
Profile's hight	9,7mm
Mat's hight	12,00mm
Mat's weight	With distance bush 3mm – 12,5kg With distance bush 5mm – 11,5kg
Available colours	Aluminium bracket profiles, flat bars: natural – silver, on request all RAL colours Anti-slip rubber: black, grey, brown

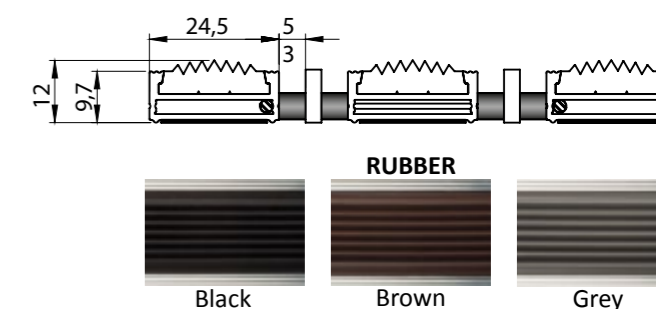

Broxorip

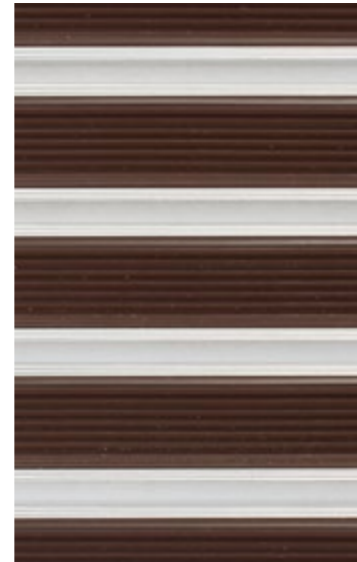
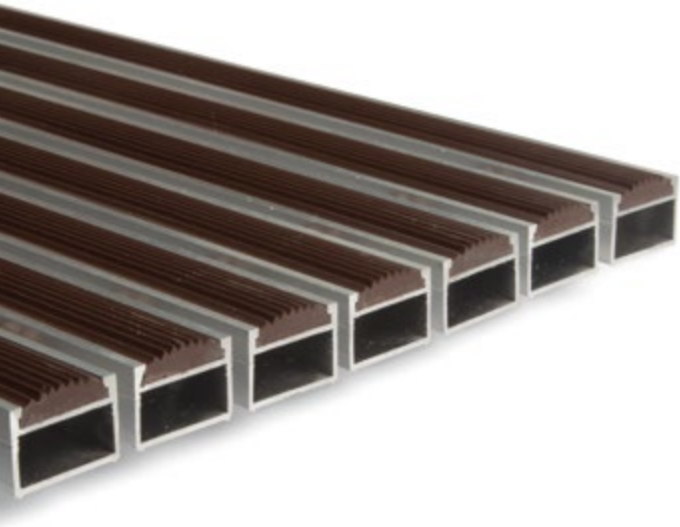

DESCRIPTION: Rolled doormat, dedicated for outdoor and indoor spaces (zone no 1 and 2) for shoe sole cleaning. With used anti-slip rubber. To be used in high-traffic pedestrian places with participation of shopping trolleys, wheelchairs for example for hotels, office buildings, shops and residential buildings.

DATA SHEET

Application area	Outdoor and indoor use
Material	Bracket profile – aluminium - alloy 6060T6 Cleaning contribution: anti-slip rubber (7 teeth) – PVC – 72Sha Stainless steel wire rope - 2 mm diameter Distance bushes: width 3mm, 5mm - PVC of hardness 75Sha Nickel plated terminal keys, acoustic tape (bottom of the profiles)
Profile's height	17,5mm
Mat's height	20,00mm
Mat's weight	With distance bush 3mm – 14,00kg With distance bush 5mm – 13,00kg
Available colours	Aluminium bracket profiles: natural – silver, on request all RAL colours Anti-slip rubber: black, grey, brown

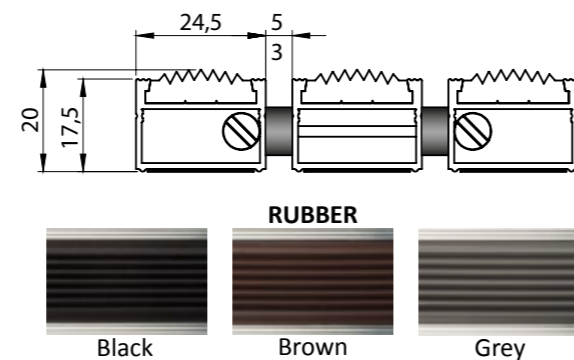

LIDER

LIDER



Broxorip-KK



DESCRIPTION: Rolled doormat, dedicated for outdoor and indoor spaces (zone no 1 and 2) for shoe sole cleaning. With used anti-slip rubber and aluminium flat bar. To be used in high-traffic pedestrian places with participation of shopping trolleys, wheelchairs for example for hotels, office buildings, shops and residential buildings.

DATA SHEET

Application area	Outdoor and indoor use
Material	Bracket profile – aluminium - alloy 6060T6 Aluminium flat bar – 3x20mm- alloy 6060T6 Cleaning contribution: anti-slip rubber (7 teeth) – PVC – 72Sha Stainless steel wire rope - 2 mm diameter Distance bushes: width 3mm, 5mm - PVC of hardness 75Sha Nickel plated terminal keys, acoustic tape (bottom of the profiles)
Profile's height	17,5mm
Mat's height	20,00mm
Mat's weight	With distance bush 3mm – 15,5kg With distance bush 5mm – 14,5kg
Available colours	Aluminium bracket profiles, aluminium flat bar: natural – silver, on request all RAL colours Anti-slip rubber: black, grey, brown

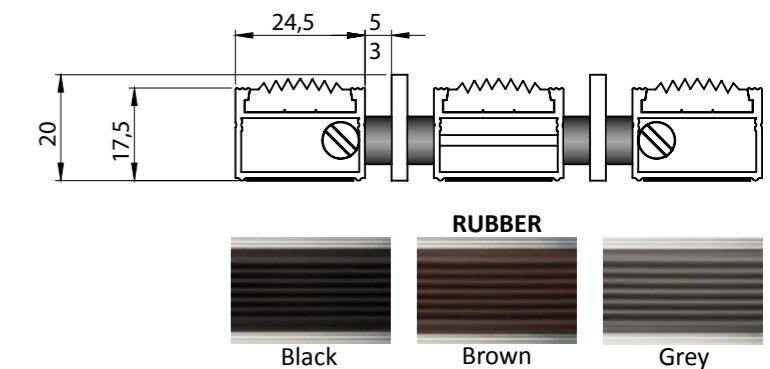

Broxorip-Spezial

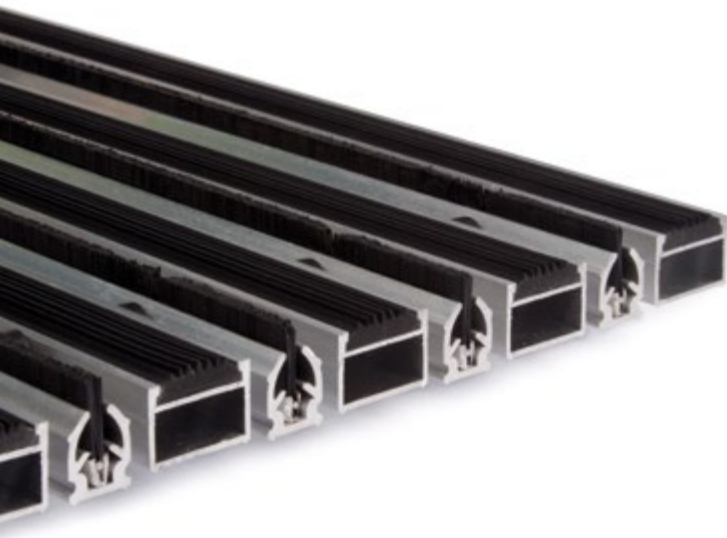

DESCRIPTION: Rolled doormat, dedicated for outdoor and indoor spaces (zone no 1 and 2) for shoe sole cleaning. With used anti-slip rubber and scraping brush. 1:1 rubber to brush ratio. To be used in high-traffic pedestrian places with participation of shopping trolleys, wheelchairs for example for hotels, office buildings, shops and residential buildings.

DATA SHEET

Application area	Outdoor and indoor use
Material	Bracket profile – aluminium - alloy 6060T6 Cleaning contribution: anti-slip rubber (7 teeth) – PVC – 72Sha, Nylon scraping brush – nylon 0,4mm Stainless steel wire rope - 2 mm diameter Distance bushes: width 3mm, 5mm - PVC of hardness 75Sha Nickel plated terminal keys, acoustic tape (bottom of the profiles)
Profile's hight	17,5mm
Mat's hight	22,00mm
Mat's weight	With distance bush 3mm – 17,5kg With distance bush 5mm – 16,5kg
Available colours	Aluminium bracket profiles: natural – silver, on request all RAL colours Anti-slip rubber: black, grey, brown Scraping brushes: black, grey, brown, red, green, blue

SCRAPING BRUSHES

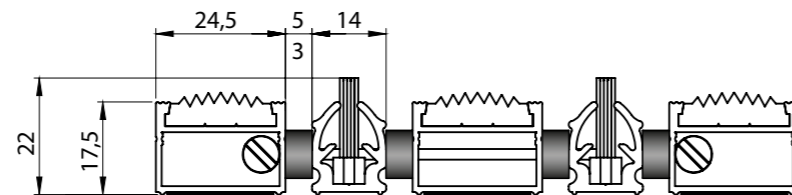
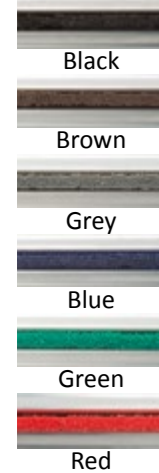

RUBBER

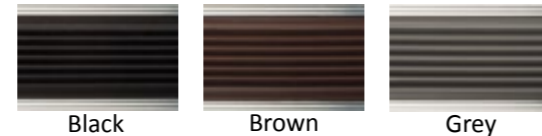

Broxorip-Spezial 2:1

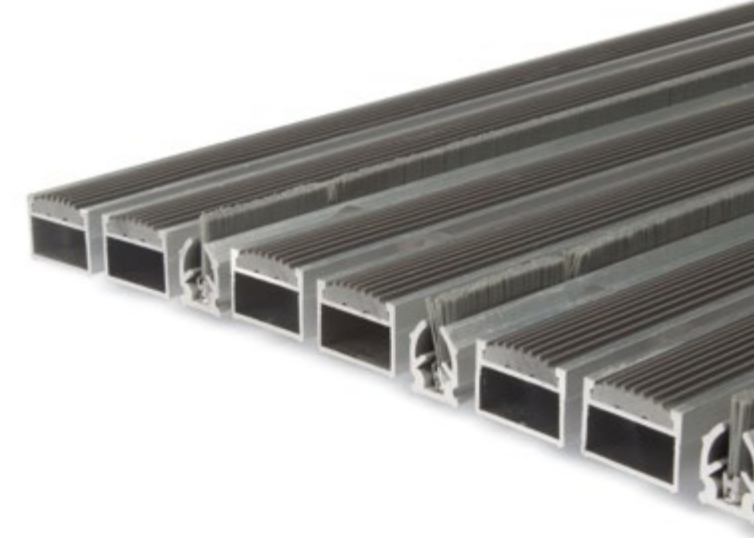

DESCRIPTION: Rolled doormat, dedicated for outdoor and indoor spaces (zone no 1 and 2) for shoe sole cleaning. With used anti-slip rubber and scraping brush. 2:1 rubber to brush ratio. To be used in high-traffic pedestrian places with participation of shopping trolleys, wheelchairs for example for hotels, office buildings, shops and residential buildings.

DATA SHEET

Application area	Outdoor and indoor use
Material	Bracket profile – aluminium - alloy 6060T6 Cleaning contribution: anti-slip rubber (7 teeth) – PVC – 72Sha, Nylon scraping brush – nylon 0,4mm Stainless steel wire rope - 2 mm diameter Distance bushes: width 3mm, 5mm - PVC of hardness 75Sha Nickel plated terminal keys, acoustic tape (bottom of the profiles)
Profile's hight	17,5mm
Mat's hight	22,00mm
Mat's weight	With distance bush 3mm – 16,00kg With distance bush 5mm – 15,00kg
Available colours	Aluminium bracket profiles: natural – silver, on request all RAL colours Anti-slip rubber: black, grey, brown Scraping brushes: black, grey, brown, red, green, blue

SCRAPING BRUSHES

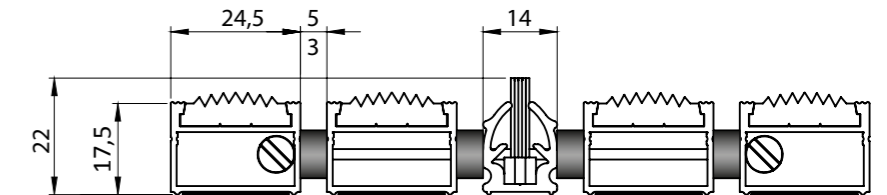

RUBBER

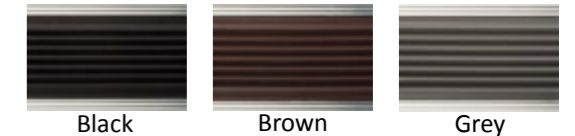

LIDER

Broxorip-Spezial 3:1

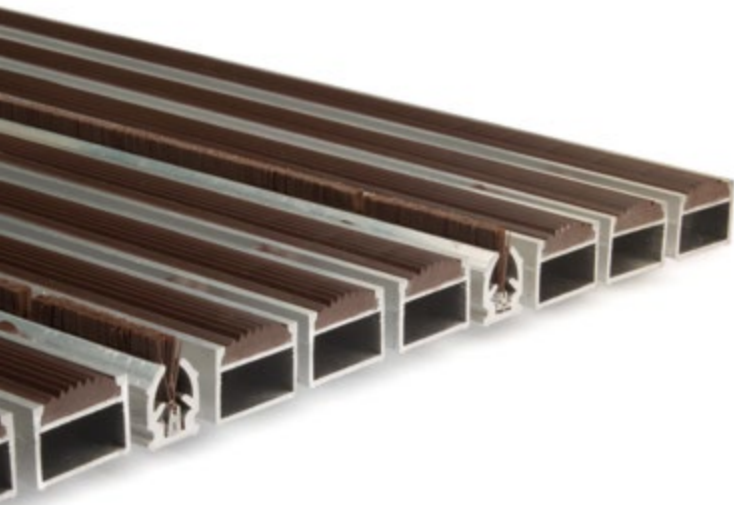

DESCRIPTION: Rolled doormat, dedicated for outdoor and indoor spaces (zone no 1 and 2) for shoe sole cleaning. With used anti-slip rubber and scraping brush. 3:1 rubber to brush ratio. To be used in high-traffic pedestrian places with participation of shopping trolleys, wheelchairs for example for hotels, office buildings, shops and residential buildings.

DATA SHEET

Application area	Outdoor and indoor use
Material	Bracket profile – aluminium - alloy 6060T6 Cleaning contribution: anti-slip rubber (7 teeth) – PVC – 72Sha, Nylon scraping brush – nylon 0,4mm Stainless steel wire rope - 2 mm diameter Distance bushes: width 3mm, 5mm - PVC of hardness 75Sha Nickel plated terminal keys, acoustic tape (bottom of the profiles)
Profile's hight	17,5mm
Mat's hight	22,00mm
Mat's weight	With distance bush 3mm – 15,50kg With distance bush 5mm – 14,50kg
New Item	New variable
Available colours	Aluminium bracket profiles: natural – silver, on request all RAL colours Anti-slip rubber: black, grey, brown Scraping brushes: black, grey, brown, red, green, blue

SCRAPING BRUSHES

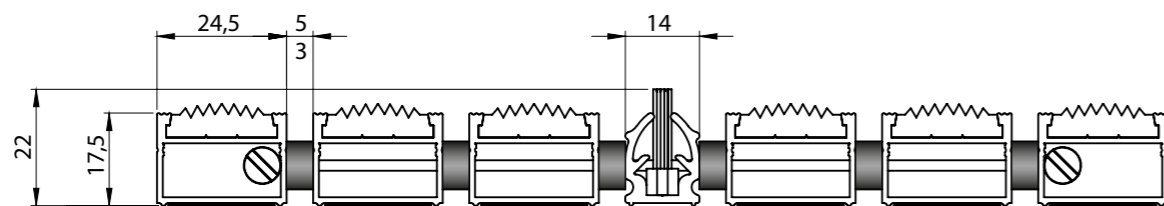
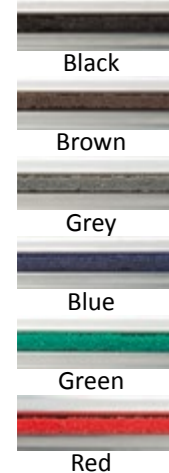

RUBBER



LIDER

Broxoflex



DESCRIPTION: Rolled doormat, dedicated for outdoor and indoor spaces (zone no 1) for shoe sole cleaning from fine and coarse dirt. With used scraping brushes made from hard, rigid nylon. To be used in high-traffic pedestrian places with participation of shopping trolleys, wheelchairs for example for hotels, office buildings, shops and residential buildings.

DATA SHEET

Application area	Outdoor and indoor use
Material	Bracket profile – aluminium - alloy 6060T6 Cleaning contribution: nylon scraping brush – nylon 0,4mm Stainless steel wire rope - 2 mm diameter Distance bushes: width 3mm, 5mm - PVC of hardness 75Sha Nickel plated terminal keys
Profile's hight	17,5mm
Mat's hight	22,00mm
Mat's weight	With distance bush 3mm – 24,00kg With distance bush 5mm – 21,50kg
Available colours	Aluminium bracket profiles: natural – silver, on request all RAL colours Scraping brushes: black, grey, brown, red, green, blue

SCRAPING BRUSHES

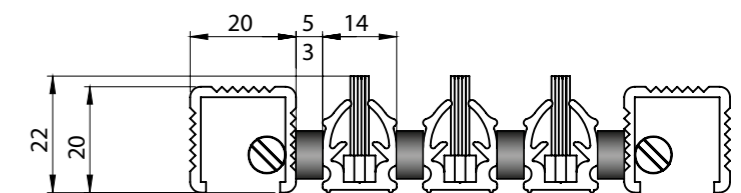

Broxoflex-EK

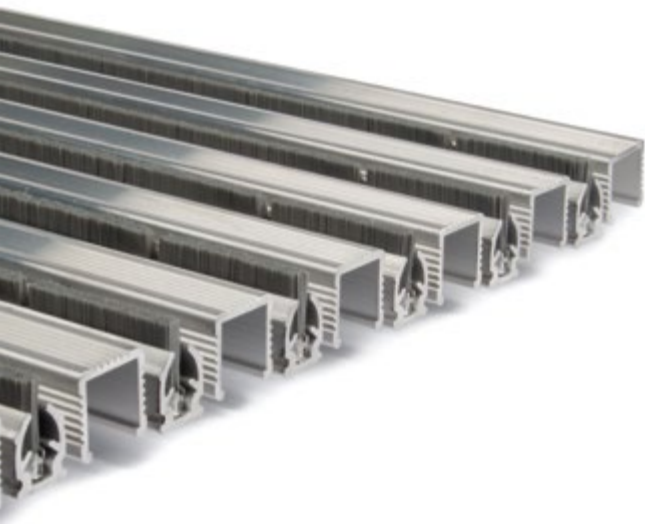

DESCRIPTION: Rolled doormat, dedicated for outdoor and indoor spaces (zone no 1) for shoe sole cleaning from fine and coarse dirt. Specially dedicated for production halls. With used ribbed c-profile and scraping brushes made from hard, rigid nylon. To be used in high-traffic pedestrian places inside industrial objects and production halls.

DATA SHEET

Application area	Outdoor and indoor use
Material	Bracket profile – aluminium - alloy 6060T6 Cleaning contribution: nylon scraping brush – nylon 0,4mm Aluminium c-profile ribbed – alloy 6060T6 Stainless steel wire rope - 2 mm diameter Distance bushes: width 3mm, 5mm - PVC of hardness 75Sha Nickel plated terminal keys
Profile's height	Brush profile's height - 17,5mm, Ribbed c-shaped profile - 20mm
Mat's height	22,00mm
Mat's weight	With distance bush 3mm – 18,00kg With distance bush 5mm – 17,00kg
Available colours	Aluminium bracket profiles, ribbed c-profile: natural – silver, on request all RAL colours Scraping brushes: black, grey, brown, red, green, blue

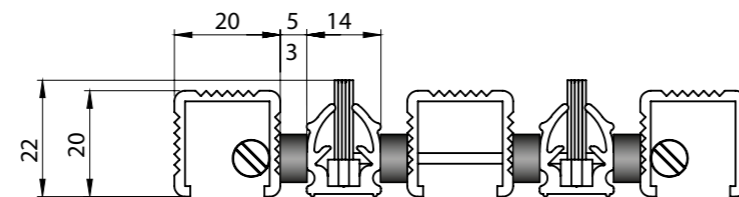

SCRAPING BRUSHES

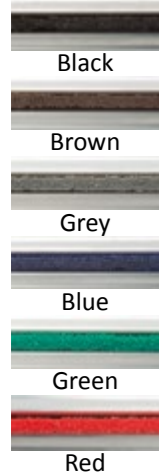

LIDER

LIDER

Broxoflex-CB

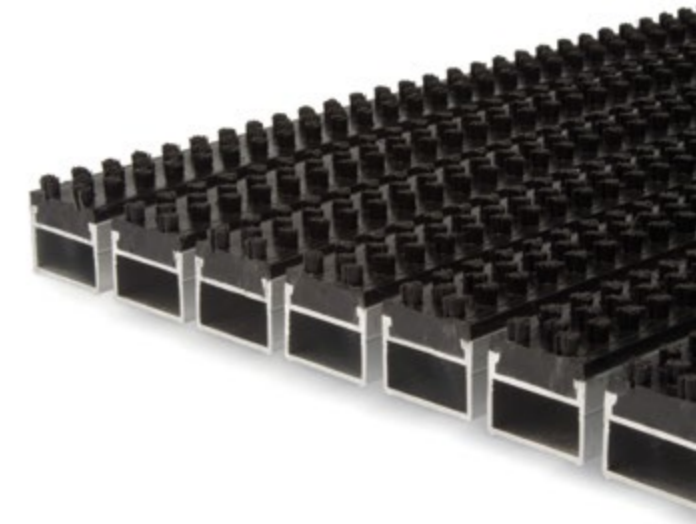

DESCRIPTION: Rolled doormat, dedicated for outdoor and indoor spaces (zone no 1) for shoe sole cleaning from fine and coarse dirt. With used three-row strip brush. To be used in high-traffic pedestrian places with participation of shopping trolleys, wheel-chairs for example for hotels, office buildings, shops and residential buildings.

DATA SHEET

Application area	Outdoor and indoor use
Material	Bracket profile – aluminium - alloy 6060T6 Cleaning contribution: three-row strip brush - PVC +nylon Stainless steel wire rope - 2 mm diameter Distance bushes: width 3mm, 5mm - PVC of hardness 75Sha Nickel plated terminal keys, acoustic tape (bottom of the profiles)
Profile's height	17,5mm
Mat's height	25,00mm
Mat's weight	With distance bush 3mm – 16,00kg With distance bush 5mm – 15,00kg
Available colours	Aluminium bracket profiles: natural – silver, on request all RAL colours Three-row strip brush :black

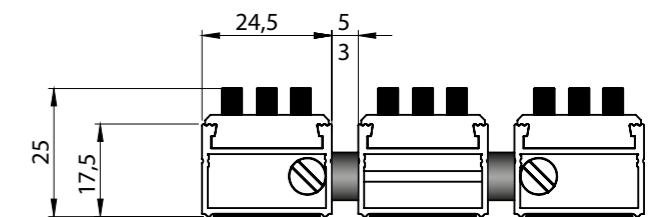

Usage instruction and conservation of objects' doormats floor system

Usage of system doormats

System doormats made from aluminium profiles are dedicated for service of pedestrian traffic in closed spaces inside and outside of buildings.

Cleaning of system doormats

Main doormats' task is collection of contaminations from shoes of doormats users.

To realize this task properly it's crucial to have doormats periodically cleaned from accumulating in spaces between profiles: dirt, larger contaminating elements (papers, cigarettes, matches, stones, etc.)

For trouble-free doormats life we recommend following mat cleaning methods:

1. Outer cleaning (from the top) by Hoover – it's recommended specially in summer time. When mat doesn't collect large amount of water.
2. Outer cleaning (from the top) from bigger dirt – by manual tools (brush, broom).
3. Inner cleaning of mat's aperture – recommended periodically, depending on traffic intensity, no less frequently than once per 14 days.

After cleaning doormat from the top we should roll it and remove (sweep or Hoover) dirt which is collected in aperture in between profile, with special attention to edges of the aperture (just beside restrictive angle bars) and corners of the aperture.

Not properly cleaning of this places will cause increase of contamination layers and mat stuffing above upper edge of aperture.

In order to keep the structure of mat's material, mat should be cleaned from any sticky substances carried by shoes. Any mat cleaning should be done using soft tools, without sharp coats (metal or rice brushes). Mats should be cleaned along aluminium profiles.

Mat's outer wet cleaning – done in autumn-winter period, when mats should be cleaned from collected wet dirt. During cleaning all corrosive chemicals should be avoided. It's recommended to use lukewarm water with dish soap addition. After mat's wet cleaning it should be dried before further usage. The mat shouldn't be dried by outer heaters. Temperature differences and materials' humidity will cause deformations and will have negative input on glued parts of mats (carpet, rubber). Using wet doormat' will run-down cleaning function of profiles' with carpet contribution.

ATTENTION:

Our system doormats clean shoes by friction of shoe on outer facing (carpet, rubber, brush) by what the facing is wearing out. There is no way to predict when the facing will be totally wore out because it depends on traffic intensity, quantity of dirt and doormats cleaning frequency. Main condition of proper doormats exploitation is also ideal floor surface. It's very important that mat adheres with its whole plane to the floor.



Installation of doormats manufactured by Lider company by using aluminium frames

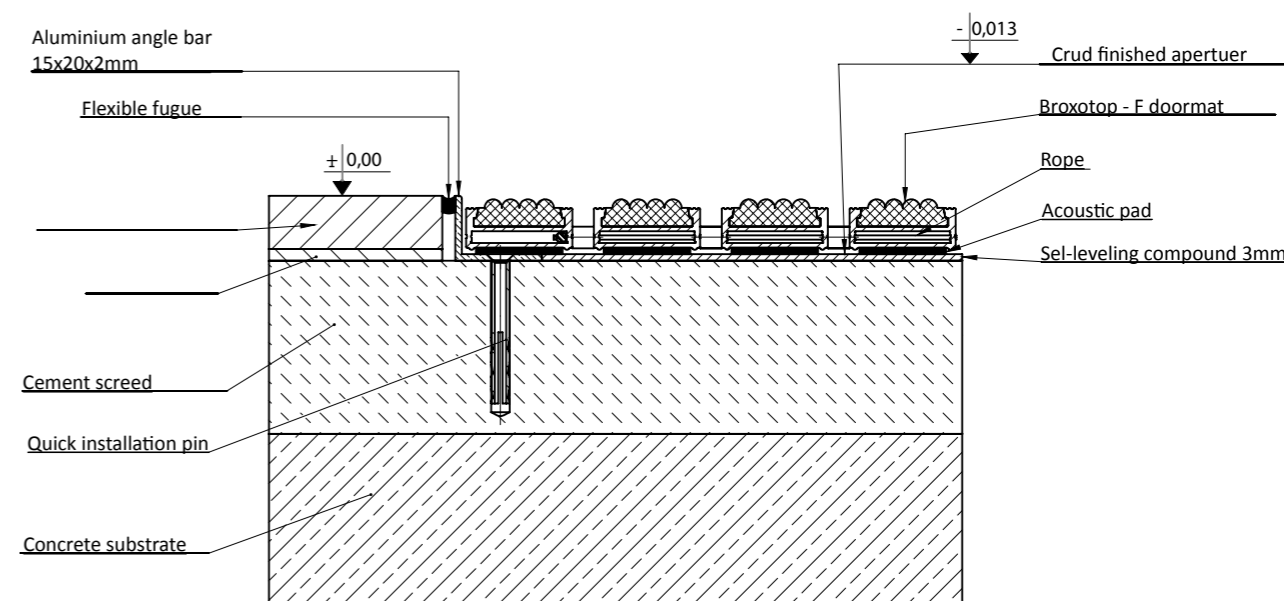
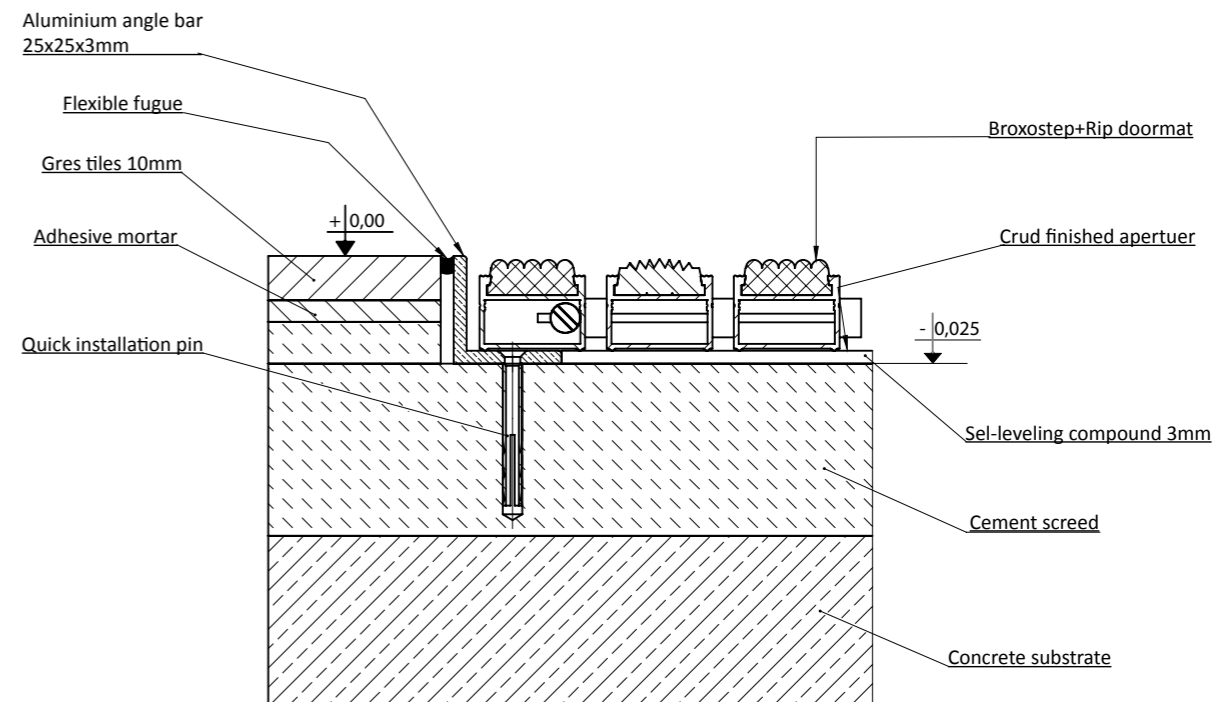

Division of our doormats into modules

WRONG

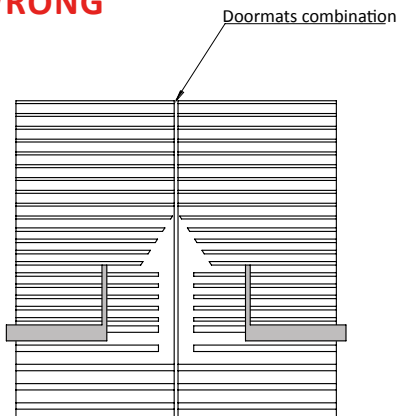

GOOD

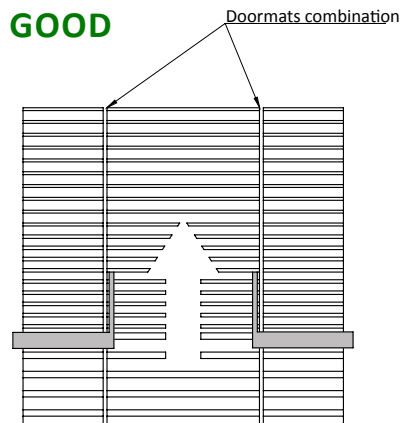

WRONG

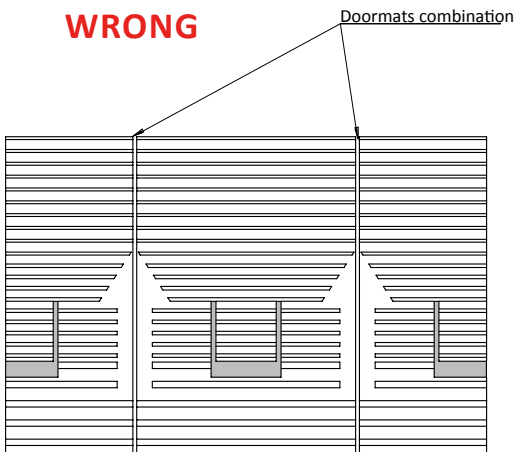

GOOD

